



N6 Hinge

Surface mount · 304 or 316 Stainless Steel

- Stamped hinge construction
- High gloss finish option
- Covered hinge option

Material and Finish

Stainless Steel, passivated or high gloss

Performance Details

Radial load:

Max. static load: 534 N (120 lbf)

Axial load:

Max. static load: 534 N (120 lbf)

Installation Notes

Screws not supplied

Install hinge with M4 (8-32) CSK

For optional covers:

Order covers separately.

Clean hinge leaf surface to remove dirt, oil or grease.

Remove backing from pre-applied adhesive. Place cover over leaf.

Press firmly to activate adhesive.

Part Number

Order hinge and optional covers separately

Style 1 (Part Number see table)

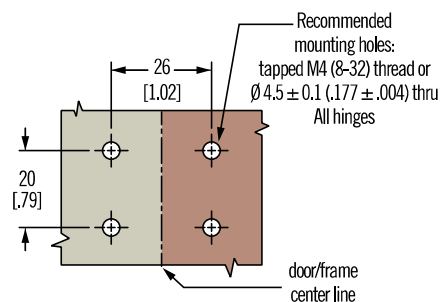
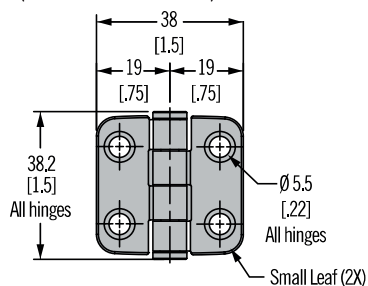

Style 2 (Part Number see table)

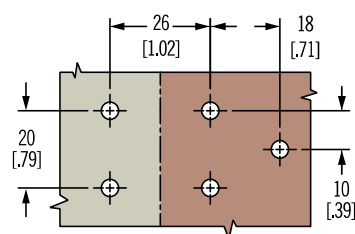
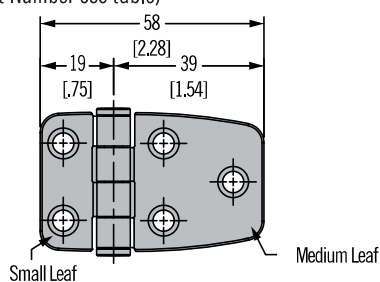

Style 3 (Part Number see table)

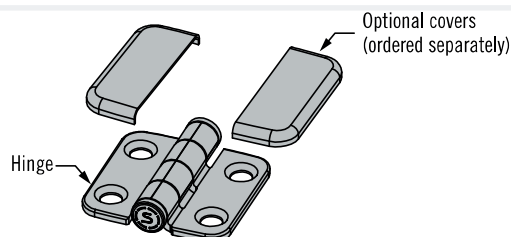
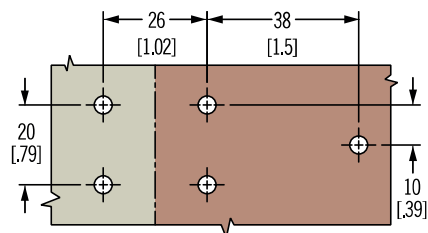
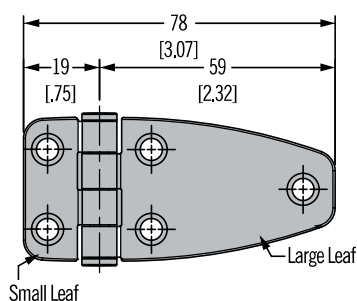

Style	Part Number				
	304 Stainless Steel, Passivated	316 Stainless Steel, High Gloss			
	Hinge	Hinge	Small Leaf Cover	Medium Leaf Cover	Large Leaf Cover
1	N6-4E-422-20	N6-4E-422-24	N6-C-42-24 (2 each)	—	—
2	N6-4E-424-20	N6-4E-424-24	N6-C-42-24	N6-C-44-24	—
3	N6-4E-426-20	N6-4E-426-24	N6-C-42-24	—	N6-C-46-24
4	N6-4E-444-20	N6-4E-444-24	—	N6-C-44-24 (2 each)	—
5	N6-4E-446-20	N6-4E-446-24	—	N6-C-44-24	N6-C-46-24
6	N6-4E-466-20	N6-4E-466-24	—	—	N6-C-46-24 (2 each)

N6 Hinge

Surface mount · 304 or 316 Stainless Steel



Style 4 (Part Number see table)

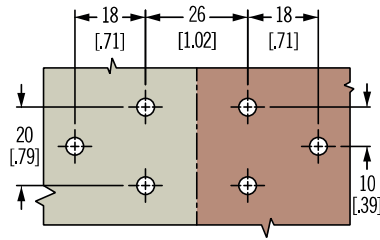
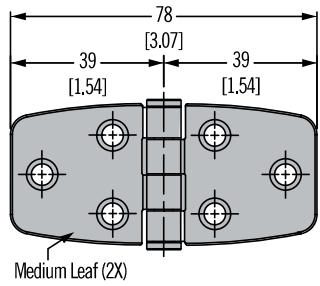

Style 5 (Part Number see table)

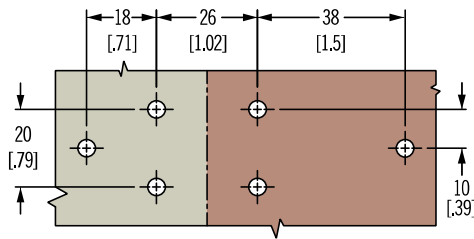
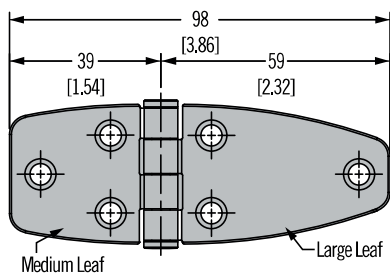

Style 6 (Part Number see table)

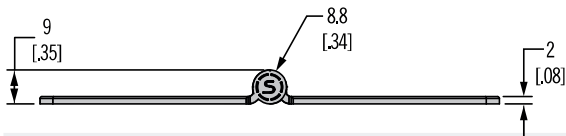
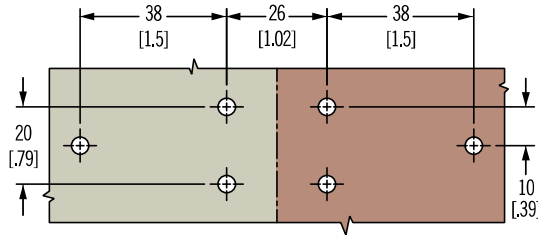
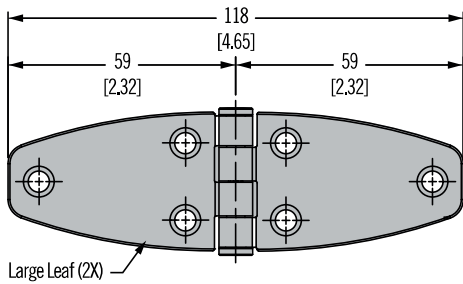

Optional covers ordered separately

For use with small leaf: part number N6-C-42-24

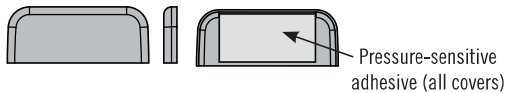

For use with large leaf: part number N6-C-46-24

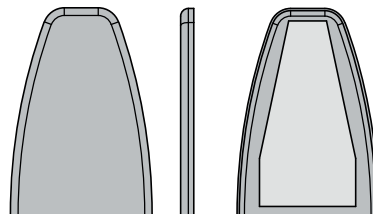

For use with medium leaf: part number N6-C-44-24

